

**BASE 70**

# **Industrial Door Drive**

## **Control System**

### **Instructions And User Guide**

Version 1.8

# CONTENTS

1. GENERAL SAFETY INFORMATION .....	1
2. TECHNICAL DATA .....	2
3. OVERVIEW OF CONTROL .....	3
4. BASIC BUTTON INSTRUCTION .....	4
5. COMMON FUNCTION QUICK SETTING INSTRUCTION .....	5
6. QUICK SETTING TO GUIDE THE DRIVE WORKS BY "AAS" .....	6-7
7. FUNCTION TABLE MENU ITEMS .....	8
8. FUNCTION MENU DESCRIPTION .....	9-32
9. FAULTS .....	33-34
10. TX/RX FUNCTION MODULE DESCRIPTION .....	35-36
11. FUNCTION WIRING DIAGRAM .....	36-43

# **GENERAL SAFETY INFORMATION**

## **Specified use**

The industrial door drives intended for a power-operated door with a drive unit. The safe operation is only guaranteed with specified normal use. The drive unit is to be protected from rain, moisture and aggressive ambient conditions. No liability for damage caused by other applications or non-observance of the information in the manual.

Modifications are only permitted with the agreement of the manufacturer. Otherwise the Manufacturer's Declaration shall be rendered null and void.

## **Safety information**

Installation and commissioning are to be performed by skilled personnel only. Only trained electrical craftsmen are permitted to work on electrical equipment. They must assess the tasks assigned to them, recognize potential danger zones and be able to take appropriate safety measures.

Installation work is only to be carried out with the supply off. Observe the applicable regulations and standards.

**WARNING:** Important safety instructions.

- It is vital for the safety of people to follow all instructions. Keep this manual.
  - Do not let children play with the appliance or control devices including remote controls.
  - Follow all instructions, as incorrect installation can lead to serious injuries.
  - The actuating element of the dependent switch must be positioned so that it can be seen directly on the driven part, but out of reach of the moving parts. If it is not actuated by a key, it must be placed at a minimum height of 1.5 m and not accessible to the public;
- after installation, make sure that the mechanism is set correctly and that the protection system and any manual controls work properly.

## **Coverings and protective devices**

Only operate with corresponding coverings and protective devices. Ensure that gaskets are fitted correctly and that cable glands are correctly tightened.

## **Weighted sound pressure emission level A of the motor**

LpA less than or equal to 70 dB (A).

**WARNING Z101** . - The effect of noise emitted by the structure, including the driven part to which the drive will be connected, is not considered.

## **Spare parts**







Only use original spare parts.

## TECHNICAL DATA









Model	BASE 70
Max. output torque (Nm)	70 Nm
Rated output torque (Nm)	50 Nm
Output speed (rpm)	24–32 rpm
Output shaft/hollow shaft (mm)	φ 25.4 mm
Static holding torque (Nm)	400 Nm
Door area (m <sup>2</sup> )	≤28 m <sup>2</sup>
Input voltage (V)	110–127V or 220–240V or 380–420V
Motor power (W)	550 W
Control system	24V DC
Thermal protection temperature (° C)	105 ° C
Max. cycles per hour (Cycle)	20 cycles
Class of protection	IP 54
Limit switch range (maximum revolutions of output shaft / hollow shaft)	15 turns
Temperature range (° C)	–20° C ~ +40° C

# OVERVIEW OF CONTROL









	<p>Digital display :</p> <ul style="list-style-type: none"> <li>• The first boot up displays <b>FL</b>, then count down from <b>99</b> to <b>00</b>.</li> <li>•  : Without travel limit set.</li> <li>•  : With travel limit set.</li> </ul>
	<p>Button : UP/STOP</p>
	<p>Button : STOP</p>
	<p>Button: DOWN/STOP</p>

## BASIC BUTTON INSTRUCTION

Item	Button	Description
1.		Short press: Confirm setting; Long press: Enter the function menu setting
2.		Short press: Adjust the function menu Long press: Restore factory setting
3.		Short press: Adjust the function menu Long press: Running cycle counter inquiry
4.		Short press: Return Long Press: Enter into rail system selection (Refer to the quick operation guide for details – Page 6)
5.		Short press: Quick activate “AUTO CLOSE” function
6.		Short press: Quick activate “FORCE MARGIN” function
7.		RJ45 Connection port: Drive head & Control box
8.		RJ11 Connection port: Drive head & Wired wall button

## COMMON FUNCTION QUICK SETTING INSTRUCTION

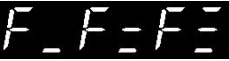











Function Item	Operation	Description
AUTO CLOSE	Short press: 	<p><b>Important:</b></p> <p>The "AUTO CLOSE" only can be activated when the Photo beam or light curtain has been correctly installed and the photo beam function has been enabled from function menu (Refer to page 17–18 – Menu 5).</p> <ul style="list-style-type: none"> <li>Short press the "AUTO CLOSE" button, when the indicator light is turned on. It means the "AUTO CLOSE" function has been activated.</li> </ul> <p>(Default: The door only can auto close while in the open limit position. And the Auto Close time is 15 seconds).</p> <p>Refer to page 16 – Menu 4 to change any setting for AUTO CLOSE conditions or time if necessary.</p> <p><b>Note:</b> If there is no any photo beam or light curtain installed, the door can not be closed, and the LED display will show the letter "E6" as an indication.</p> <ul style="list-style-type: none"> <li>Short press the "AUTO CLOSE" button, when the indicator light is turned off. It means the "AUTO CLOSE" function has been dis-activated.</li> </ul>
Force Adjustment	Short press: 	<ul style="list-style-type: none"> <li>Short press the button, the digital display will indicate the current force level firstly</li> <li>Continually short press the button: Incremental rolling display the force level between  to </li> </ul> <p>L1: Minimum force level ;            L9: Maximum force level</p> <p><b>Note: L3 to L7 is recommended.</b></p>
Running Cycle Counter Inquiry	Long press the button for 6 seconds: 	<ul style="list-style-type: none"> <li>The digital will rolling display  , it represents the drive has been 10 running cycles worked.</li> </ul> <p><b>Note: The running cycles is displayed in 6 digits</b></p>
Restore Factory Setting	Long press the button for 10 seconds: 	<ul style="list-style-type: none"> <li>The digital will rolling display  , then release the button , it means the drive has been restored to factory setting.</li> </ul> <p><b>Note: The running cycle counter record will not be cleared.</b></p>

# QUICK SETTING TO GUIDE THE DRIVE WORKS

## BY "AAS" (Auto adaptive system)

**Important:**

- "AAS" will automatic identify the door condition to define a best program for its "Open/ Close speed", "Soft start/ soft stop ranges" and "Force sensitivity".
- A quick setting guide the drive will work properly after below operation.

<p>1. Long press:</p>  <p>over 3 seconds to enter into RAIL SYSTEM selection</p>	<p>All of the indicator lights are light up constantly for "SL,HL,VL" and then off.</p> <p>Then release the button until one of the indicator lights flashes.</p> 
<p>2. Short press:</p>  <p>to select the corresponded RAIL SYSTEM of the door.</p>	<p>The corresponded light flashes for "SL,HL,VL"</p>  <ul style="list-style-type: none"> <li>  <p>SL: Standard lift sectional doors with cylindrical cable drum</p> </li> <li>  <p>HL: High lift sectional doors with cylindrical-conical cable drum</p> </li> <li>  <p>VL: Vertical lift sectional doors with conical cable drum</p> </li> </ul>
<p>3. Short press:</p>  <p>to confirm the selected Rail System</p>	<p>The corresponded indicator light is constant on for "SL,HL,VL"</p>  <p>Then, the digital display shows  to start the OPEN travel limit setting.</p>
<p>4. Long press:</p> 	<p>Long press the button + (Up) or - (Down) to set the door to the target OPEN limit position, then release the buttons.</p> <p>Short Press the SET button once to store the open limit position, the digital displays  to start the CLOSE travel limit setting.</p>



5. Long press:



Long press the button + (Up) or – (Down) to set the door to the target CLOSE limit position then release the buttons.

Short press the SET button once to store the CLOSE limit position, then the door drive will automatically open and close the door to store the door weight and spring balance conditions.

**Note:**

- a. If a system selection error occurs during the setting process, please

click , Execute enter to exit the setting, and then execute the first operation again.









- b. Active or change any stand alone function, refer to the below "FUNCTION TABLE MENU".



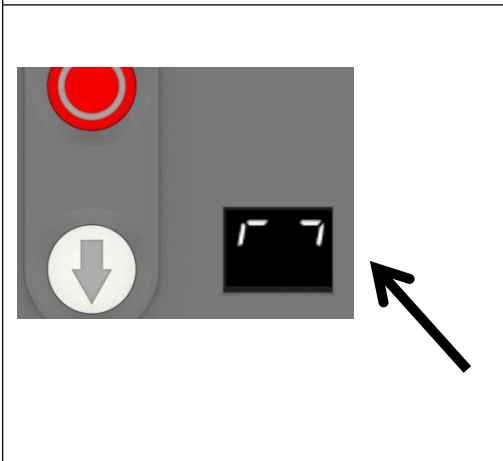

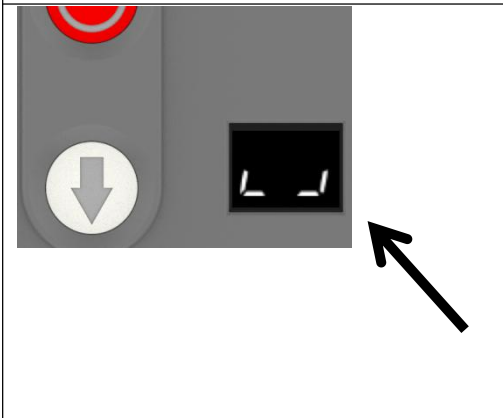







## FUNCTION TABLE MENU ITEMS



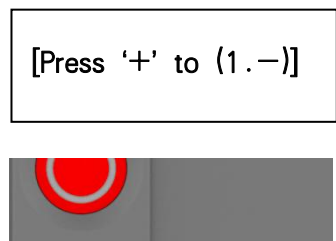



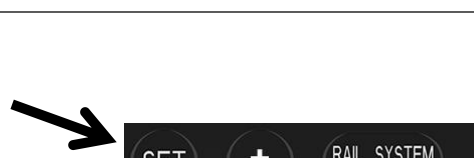



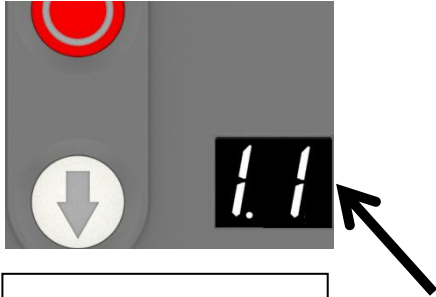

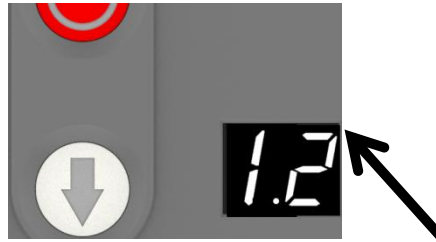

MENU	Function Table Menu	Status Indications
0	Travel Limit Setting	0-
1	Common Function Setting	1-
2	Operating Parameter Setting	2-
3	Soft Stop (during-operation) Function Setting	3-
4	AUTO CLOSE Time & Condition Setting	4-
5	Infrared Beam & Light Curtain Function	5-
6	Terminals for Extra Function Setting	6-
7	Courtesy Light Function Setting	7-
8	Maintenance Alarm Function Setting	8-
9	Gear Motor Running Direction Rotating Setting	9-



# FUNCTION MENU DESCRIPTION

**MENU 0  Travel Limit Setting**





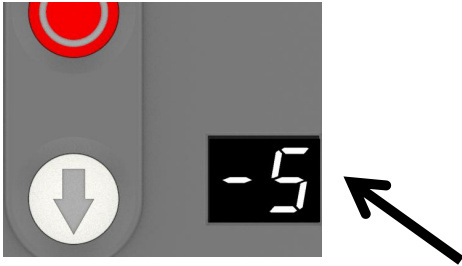





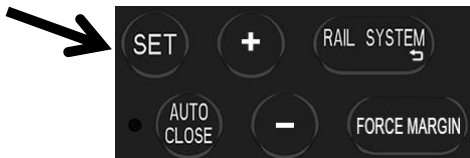



		<ul style="list-style-type: none"> <li>● Press and hold SET button for about 6 seconds to enter travel limit setting until “0.-” appears on the display then release the button.</li> </ul>
		<ul style="list-style-type: none"> <li>● Press SET to enter travel limit setting menu, the digital displays , now you can set the OPEN Position Limit.</li> <li>● Click the button + or -, to adjust the open limit position of the door. Click the SET button to confirm the open limit position.</li> </ul>
		<ul style="list-style-type: none"> <li>● Digital now displays automatically , now you can set the CLOSE position limit.</li> <li>● Click the button +/-, to adjust the close position limit. Click the SET button to confirm.</li> <li>● Then the door drive would automatically open and close the door and save the setting.</li> </ul>
		<p>PS: If there is a faulty , please check if the encoder cable is connected properly. If the connection is normal, please reset the travel limit. When you reset the travel limit, short click the UP /DOWN button and then reset the travel limit.</p>













MENU 1  Common Function Setting	
 <p>Control Box Button Mode Setting</p>	 <ul style="list-style-type: none"> <li>● Press and hold SET button for about 6 seconds to enter main menu until “0.—” appears on the display then release the button.</li> <li>● Press “+” till “1.—” appears on the display, press SET to enter common function setting menu.</li> </ul>
	 <ul style="list-style-type: none"> <li>● After press the SET button on “1.—”, “1.0” appears on the display</li> <li>● Press SET to enter the control box button mode setting.</li> </ul>
 <p>[Press ‘+’ to (1.-)]</p>	 Execution means: Long press UP to open the door, long press CLOSE to close the door
 <p>[Press ‘+’ to (1.-)]</p>	 Execution means: Click UP to open the door, long press DOWN to close the door
 <p>[Press ‘SET’ to (1.0)]</p>	 Execution means: Long press UP to open the door, click DOWN to close the door
<p>[Press ‘SET’ to (1.0)]</p>	 Execution means: Click UP to open the door, click DOWN to close the door (default)
	 <ul style="list-style-type: none"> <li>● Press and hold SET button for about 6 seconds to enter main menu until “0.—” appears on the display then release the button.</li> <li>● Press “+” till “1.—” appears on the display.</li> <li>● Press SET and “1.0” appears on the display,</li> </ul>
	<p>Remark:</p> <ul style="list-style-type: none"> <li>● When the emergency stop function works, Function  is executed as default button mode.</li> </ul>

<div style="border: 1px dashed black; border-radius: 15px; padding: 5px; margin-bottom: 10px;">  <p>Reversal Distance Ignorance Setting (Fine adjustment of the pre-close limit position— for DW)</p> </div>  <div style="border: 1px solid black; padding: 5px; width: fit-content; margin-left: auto; margin-right: auto;"> <p>[Press '+' from (1.0)]</p> </div>		<ul style="list-style-type: none"> <li>● Press “+” till “1.1” appears on the display.</li> <li>● Press SET to enter the Reversal Distance Ignorance Setting</li> </ul>
<div style="border: 1px dashed black; border-radius: 15px; padding: 5px; margin-bottom: 10px;">  <p>Fine adjustment of the open limit position</p> </div>  <div style="border: 1px solid black; padding: 5px; width: fit-content; margin-left: auto; margin-right: auto;"> <p>[Press '+' from (1.1)]</p> </div>		<ul style="list-style-type: none"> <li>● Press “+” till “1.1” appears on the display.</li> <li>● Press SET to enter the Reversal Distance Ignorance Setting</li> </ul> <p>The digital flashes  , Adjust the stalls from  to  by button +/– , Press SET to confirm the function option, automatically exit to the menu  to continue setting the next function menu, or press the RETURN button to exit the function setting.</p> <p>Remark:</p> <p>According to the door rail system and the size of the cable drum, the adjustment range of each setting is between 20 mm –50 mm (Based on the different cable drum installed).</p> <p>Default  is about 35mm.</p> <p>The calculation format is like this: [8] * 2* 2.2mm</p> <ul style="list-style-type: none"> <li>● Press and hold SET button for about 6 seconds to enter main menu until “0.—” appears on the display then release the button.</li> <li>● Press “+” till “1.—” appears on the display.</li> <li>● Press SET then “1.0” appears on the display.</li> <li>● Press “+” till “1.2” appears on the display,</li> </ul>
		<p>Press SET to enter, digital flashing display  ; Use the +/– buttons to adjust the number displayed on the digital tube between  ...  to  . Select the target parameter , press SET to confirm the function option , then</p>

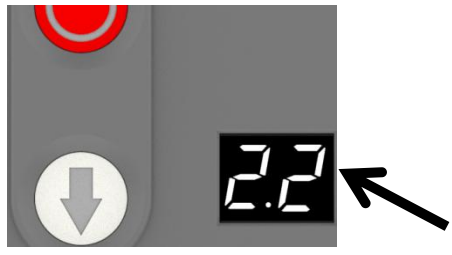
	<p>Remark : -5</p>	<p>exit to the menu <b>13</b> , Continue to set the next function menu , or press the cancel button to exit the function setting.</p>
<p><b>13</b> Fine adjustment of the close limit position</p>  <p>[Press '+' from (1.2)]</p> 	<p><b>13</b></p> <p>-5</p>	<ul style="list-style-type: none"> <li>● Press and hold SET button for about 6 seconds to enter main menu until "0.-" appears on the display then release the button.</li> <li>● Press "+" till "1.-" appears on the display.</li> <li>● Press SET then "1.0" appears on the display.</li> <li>● Press "+" till "1.3" appears on the display,</li> </ul>
	<p>-5</p>	<p>Press SET to enter , digital flashing display <b>-5</b> ; Use the +/- buttons to adjust the number displayed on the digital display between <b>-F</b> ... <b>0</b> to <b>F</b> . Select the target parameter , press SET to confirm the function option , then exit to the menu <b>13</b> .</p>
	<p>Remark :</p>	<p>Default <b>-2</b></p> <p>a. Select <b>0</b> to <b>F</b> , which means the limit position moves in the CLOSE DOOR direction .</p> <p>b. Select <b>-F</b> to <b>0</b> , which means the limit position moves in the</p>











		door center direction .
--	--	-------------------------

MENU2 <b>2.-</b> Operating Parameter Setting		
 <p>Door closing speed adjustment</p> 		<ul style="list-style-type: none"> <li>● Press and hold SET button for about 6 seconds to enter main menu until “0.-” appears on the display then release the button.</li> <li>● Press “+” till “2.-” appears on the display.</li> <li>● Press “ SET ” into the operating parameter setting menu, digital displays “2.0”</li> <li>● Press SET to enter the door closing speed adjustment menu,</li> </ul>
  <p>[Press 'SET' to (2.0)]</p>	   	<p>High speed, 100% of standard door closing speed, 50% of soft closing speed</p> <p>Medium speed, 90% standard door closing speed, 40% of soft closing speed</p> <p>Low speed, 80% standard door closing speed, 40% of soft closing speed</p> <p>Low speed, 70% standard door closing speed, 35% of soft closing speed</p>
 	  <p>Remark:</p>	<p>Low speed, 60% standard door closing speed, 35% of soft closing speed</p> <p>Low speed, 50% standard door closing speed, 35% of soft closing speed</p> <p>After quick setting the door drive, AAS function automatically select the most optimized speed for the door already. When you change the speed manually in this menu, you have to set the travel position limit again to ensure door drive works properly.</p>
 <p>Door opening speed adjustment</p>		<ul style="list-style-type: none"> <li>● Press and hold SET button for about 6 seconds to enter main menu until “0.-” appears on the display then release the button.</li> <li>● Press “+” till “2.-” appears on the display.</li> <li>● Press “ SET ” into the operating</li> </ul>

		<p>parameter setting menu, digital displays "2.0"</p> <ul style="list-style-type: none"> <li>● Press "+" till "2.1" appears on the display</li> <li>● Press SET to enter the door opening speed adjustment menu,</li> </ul>
		<p>High speed, 100% of standard door opening speed, 50% of soft closing speed</p>
		<p>High speed, 90% of standard door opening speed, 40% of soft closing speed</p>
		<p>Medium speed, 80% of standard door opening speed, 50% of soft closing speed</p>
		<p>Low speed, 70% of standard door opening speed, 40% of soft closing speed</p>
	<p>Remark:</p>	<p>After quick setting the door drive, AAS function automatically select the most optimized speed for the door already. When you change the speed manually in this menu, you have to set the travel position limit again to ensure door drive works properly.</p>
<p style="text-align: center;">         Soft closing distance adjustment     </p> 		<ul style="list-style-type: none"> <li>● Press and hold SET button for about 6 seconds to enter main menu until "0.-" appears on the display then release the button.</li> <li>● Press "+" till "2.-" appears on the display.</li> <li>● Press "SET" into the operating parameter setting menu, digital displays "2.0"</li> <li>● Press "+" till "2.2" appears on the display</li> <li>● Press SET to enter the Soft closing distance adjustment,</li> </ul>
		<p>Soft closing distance SL: 10CM, HL: 20CM, VL: 25CM</p>
		<p>Soft closing distance SL: 20CM, HL: 30CM, VL: 40CM</p>
		<p>Soft closing distance SL: 25CM, HL: 45CM, VL: 50CM</p>
		<p>Soft closing distance SL: 40CM, HL: 55CM, VL: 60CM</p>
	<p>Remark:</p>	<p>The above soft closing distance is estimated with 18-inch cable drum. The</p>



	<p>actual distance will be different according to the customer's cable drum diameter. The rail system (AAS) will automatically match the optimized soft closing distance. After the customer changes the default distance, the previous travel limit will be lost and needs to be re-learned.</p>
--	---

<b>MENU3  Soft Stop (during-operation) Function Setting</b>	
<div style="border: 1px dashed black; padding: 5px; margin-bottom: 10px;">  Soft stop (during-operation) function adjustment     </div>  	<div style="text-align: center; margin-bottom: 10px;"></div> <ul style="list-style-type: none"> <li>● Press and hold SET button for about 6 seconds to enter main menu until "0.-" appears on the display then release the button.</li> <li>● Press "+" till "3.-" appears on the display.</li> <li>● Press SET into the Soft stop (during-operation) function adjustment</li> </ul> <div style="text-align: center; margin-bottom: 10px;"></div> <p>The digital tube display , Number 1 flashing display (default).</p> <p>Adjust the stalls from  to  by buttons +/- . This function is used to control the soft stop and corresponding soft stop speed during operation. Press the SET button to confirm the selection and automatically exit the function menu.</p>
<p>Remark :</p>	<p>The soft stop function is enabled by default , Whether it is an external device or a remote control, the soft stop function is implemented during operation.</p> <p> means: Soft stop function is off</p> <p>3.1 means soft-stop will low-down the speed to 30% in 0.75 second, then stop the door</p> <p>3.2 means soft-stop will low-down the speed to 40% in 0.75 second, then stop the door.</p> <p>3.3 means soft-stop will low-down the</p>

		<p>speed to 50% in 0.75 second, then stop the door.</p> <p>3.4 means soft-stop will low-down the speed to 60% in 0.75 second, then stop the door.</p>
--	--	---

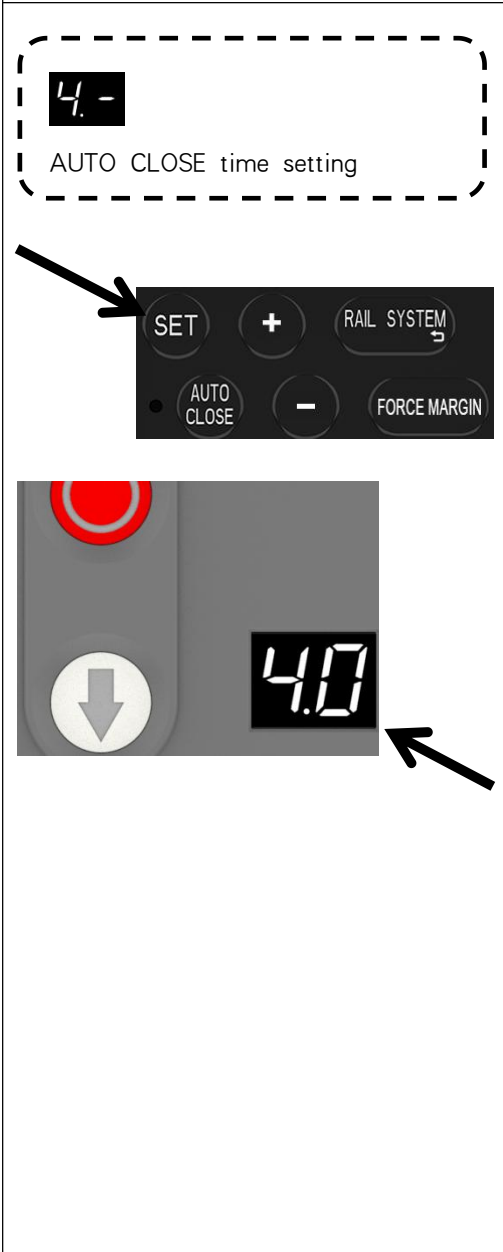
<b>MENU4</b> <b>4.-</b> <b>AUTO CLOSE Time &amp; Condition Setting</b>		
 <p>The diagram shows a control panel with a digital display showing '4.-' and the text 'AUTO CLOSE time setting' below it. Below the display is a control panel with buttons: 'SET', '+', 'RAIL SYSTEM', 'AUTO CLOSE', and 'FORCE MARGIN'. An arrow points to the 'AUTO CLOSE' button. Below this is another part of the control panel with a red emergency stop button, a grey arrow button, and a digital display showing '4.0'. An arrow points to the '4.0' display.</p>	<p><b>4.-</b></p> <p><b>03</b></p>	<ul style="list-style-type: none"> <li>● Press and hold SET button for about 6 seconds to enter main menu until "0.-" appears on the display then release the button.</li> <li>● Press "+" till "4.-" appears on the display.</li> <li>● Press SET enter into the AUTO CLOSE time and condition setting</li> <li>● Press SET again to enter, the digital displays <b>03</b> (default)</li> </ul> <p>Adjust the stalls from <b>01</b> to <b>99</b> by buttons +/-, 5 seconds per stall  AUTO CLOSE time calculation method is 5S*N, N=01—99.  The maximum AUTO CLOSE time is 495S, press the SET button to store the required AUTO CLOSE time setting, then the digital tube displays <b>4.1</b> (default) which means that it has entered the AUTO CLOSE condition setting,</p> <p>Adjust by buttons +/- from <b>4.1</b> or <b>4.2</b> or <b>4.3</b>.</p> <p>Select the corresponding function, press the SET button to save and exit the menu setting.</p>
<p>Remark:</p>		<p>The AUTO CLOSE function is turned on, which means the door is controlled by the AUTO CLOSE button on the control box.</p>
	<p><b>4.1</b></p>	<p>Condition <b>4.1</b> means: Only after the door is opened to the open limit position,</p>

		the AUTO CLOSE function is effective and starts timing.
	<b>42</b>	Condition <b>42</b> means: After the door stops at any position when opening, the AUTO CLOSE function is effective and starts timing.
	<b>43</b>	Condition <b>43</b> means: No matter where the door is open, as long as it is not at the close limit position, it will automatically close.
	Remark:	<p>a. If the infrared function is turned on, the AUTO CLOSE timing will stop when the infrared is blocked by an obstacle. After the obstacle removed, it will continue the previous timing and automatically close the door.</p> <p>b. When the door is about to close, the courtesy light flashes for warning.</p> <p>c. When the door is about to close, the warning light flashes to warn.</p> <p>d. Note: The flashing time of the warning light follows the courtesy light.</p> <p>e. The AUTO CLOSE function can only be used when the safety protection device is used correctly</p>

<b>MENUS <b>5.-</b> Infrared Beam &amp; Light Curtain Function</b>		
<div style="border: 1px dashed black; border-radius: 15px; padding: 10px; width: fit-content; margin: auto;"> <p><b>5.-</b></p> <p>Infrared Beam &amp; Light Curtain Function</p> </div>	<b>5.-</b>	<ul style="list-style-type: none"> <li>● Press and hold SET button for about 6 seconds to enter main menu until "0.-" appears on the display then release the button.</li> <li>● Press "+" till "5.-" appears on the display.</li> <li>● Press SET into the Infrared Beam &amp; Light Curtain function</li> </ul>

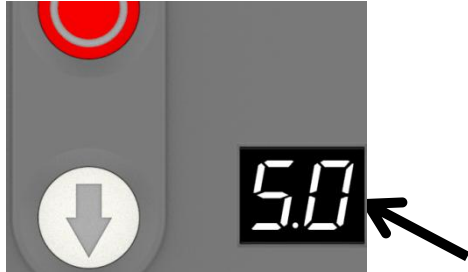

**5.1**  
Infrared Beam /Light Curtain  
& Auto-close coordination setting

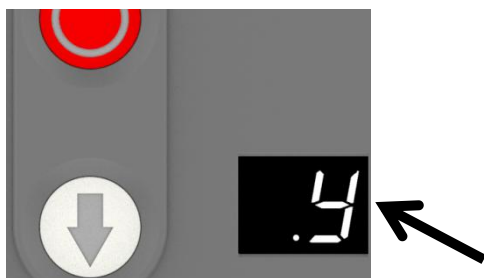
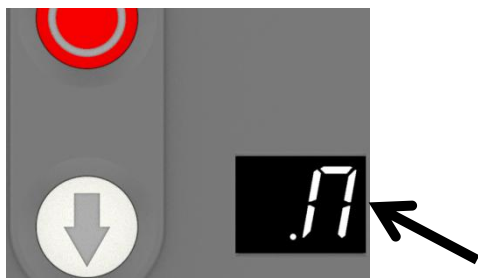

**5.0**

**.n**

**.4**

- Press SET to enter, the digital displays **5.0** (default) ;

- Adjust the stalls from **5.0** to **5.1**, **5.2** by buttons +/-.

**5.0** means: The infrared interface function is disabled.

**5.1** means: The infrared function interface is enabled.

**5.2** means: The built-in infrared beam identification function (Built-in light curtain identification function) is enabled.

Select **5.0** function (default) , Press SET to save and exit the function menu.

Select **5.1** function, which means the infrared beam function is enabled. Then after pressing the SET button to save setting, the digital displays **.n** immediately after this operation, which means entering the coordination setting of infrared function and Auto-close function.

Adjust the stalls from **.n** to **.4** by buttons +/-.

**.n** means: The infrared function is not related to the AUTO CLOSE function.

**.4** means: The AUTO CLOSE function must be enabled after the infrared function is turned on.

After selecting, press SET to save the setting and exit the function setting.

<div data-bbox="236 568 703 786" data-label="Text"> <p><b>5.2</b> Built-in Infrared Beam /Light Curtain identification setting</p> </div> <div data-bbox="252 1256 678 1563" data-label="Image"> </div>	<div data-bbox="874 197 1353 562" data-label="Text"> <p><b>Important Notice:</b> Only the Normal-Close (NC) contact is compatible with the "PE" port terminal. 2. Make sure the Infrared Beam /Light Curtain has been correctly installed, otherwise the door will be allowed for opening but not closing. The digital display displays faulty <b>E6</b>.</p> </div> <div data-bbox="746 577 1353 772" data-label="Text"> <p><b>5.2</b> <b>Important Notes:</b> Pre-Installed and tested (Refer to the menu "5.1") the built-in Infrared Beam /Light Curtain to ensure it's correct performance before select the menu .</p> </div> <div data-bbox="874 824 1353 1355" data-label="List-Group"> <ul style="list-style-type: none"> <li>● Select <b>5.2</b> function, enter into the menu of built-in Infrared Beam /Light Curtain identification setting. The display shows <b>--</b>, which means the original travel limits should be re-set.</li> <li>● Refer to the menu <b>0-</b>, or refer the quick setting guide by "AAS" (Automatic adapt system) to reset the travel limit.</li> </ul> </div> <div data-bbox="874 1400 1353 1563" data-label="Text"> <p><b>Remark:</b> The built-in infrared Beam /Light Curtain will be identified automatically during the time of travel limit learning.</p> </div> <div data-bbox="874 1653 1353 1724" data-label="Section-Header"> <p><b>Important test process after travel limit reset:</b></p> </div> <div data-bbox="874 1736 1353 2018" data-label="List-Group"> <ul style="list-style-type: none"> <li>● Press the "UP" button to open the door completely and then press the "DOWN" button to close the door, manually block the infrared sensor/light curtain during the door's closing, <b>ensure the door panel will be reversed correctly.</b></li> </ul> </div>
---	--

		<ul style="list-style-type: none"> <li>● Press the “Down” button to close the door again. The door can be closed properly which means the built-in infrared Beam /Light Curtain identification function works correctly.</li> </ul>
	Remark :	<ol style="list-style-type: none"> <li>1. Only the Normal-Close (NC) contact is compatible with the “PE” port terminal .</li> <li>2. Make sure the Infrared Beam /Light Curtain has been correctly installed, otherwise the door will be allow for opening but not closing. The digital displays faulty  .</li> </ol>

## MENU6 **6.-** Terminals for Extra Function Setting

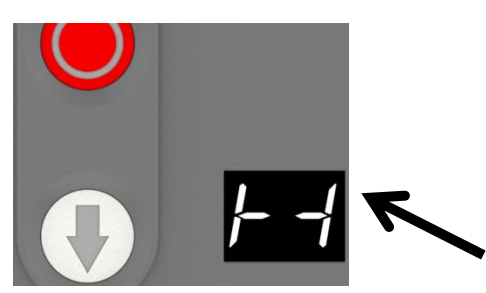
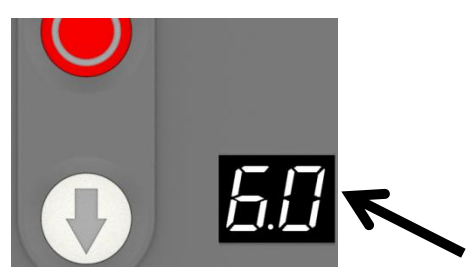
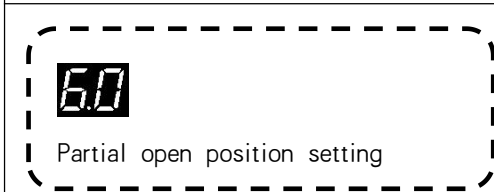

**6.0**

- Press and hold SET button for about 6 seconds to enter main menu until “0.-” appears on the display then release the button.
- Press “+” till “6.-” appears on the display.
- Press SET then appears “6.0” on the display
- Press SET enter into the Partial open position setting
- Press SET to enter the function menu, digital quickly display **1-1**, Then it flashes **.5**,
- Adjust the stalls from **.1** to **.9** by buttons+/- . (9 stalls represent 10%–90% of the door travel limit)
- Press SET to confirm and exit to the menu **10**.

You can continue to set the next function menu. Or press the RETURN button to exit the function setting.

Remark :















**.5** (default).

It means that the partial open door position is 50% of the full travel limit.











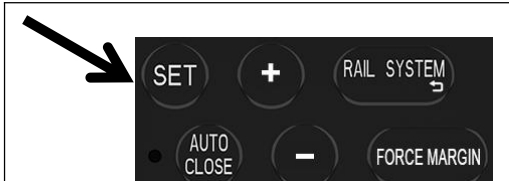
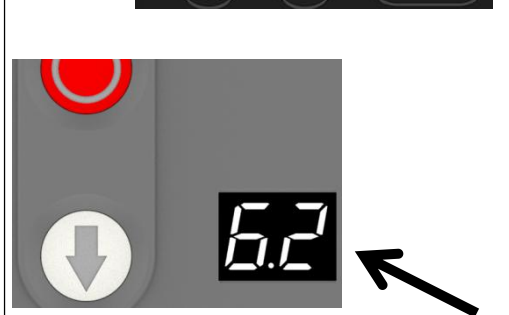

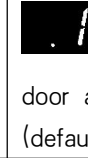
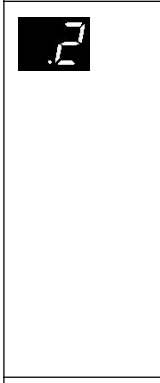
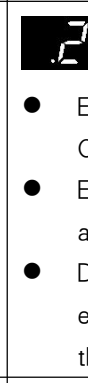
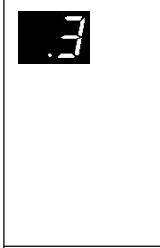
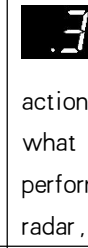
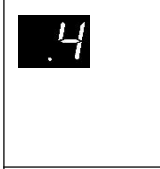

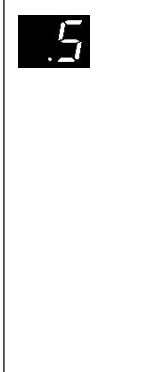
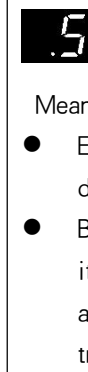
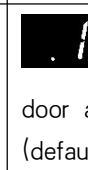

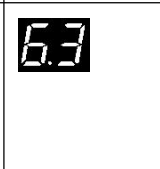

**6.1**

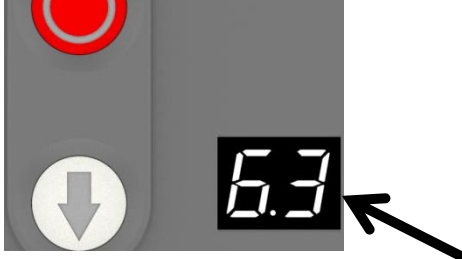













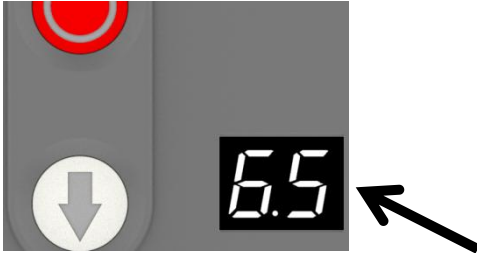

- Press and hold SET button for about 6 seconds to enter main menu until “0.-” appears on the display then release the button.
- Press “+” till “6.-” appears on the display.
- Press SET then appears “6.0” on the display
- Press “+” till “6.1” appears on the display.

		<ul style="list-style-type: none"> <li>● Press SET enter into the PB1 Port function setting.</li> </ul>
		 Execute OPEN—STOP—CLOSE the door action. Single—cycle function
		 <ul style="list-style-type: none"> <li>● Execute CLOSE the door action ONLY at the open limit position.</li> <li>● Execute OPEN the door action ONLY at the close limit position.</li> <li>● Door opening action will be executed at any position other than the close/open limit position</li> </ul>
		 Execute ONLY OPEN the door action. No matter where the motor is and what state is triggered, the motor will perform ONLY OPEN action (Including radar, infrared sensors trigger)
		 Execute PARTIAL OPEN the door function. Refer to 
		 Execute Community function. (default) Means: <ul style="list-style-type: none"> <li>● Execute ONLY OPEN the door action during the door closing process</li> <li>● But during the door opening process, it will not execute OPEN the door action, even though the motor is triggered</li> </ul>
	Remark:	 Execute Community function. (default)
<div style="border: 1px dashed black; padding: 5px; display: inline-block;">  </div> PB2 Port function setting (NO)		<ul style="list-style-type: none"> <li>● Press and hold SET button for about 6 seconds to enter main menu until “0.—” appears on the display then release the button.</li> <li>● Press “+” till “6.—” appears on the display.</li> <li>● Press SET then appears “6.0” on the display</li> </ul>











		<ul style="list-style-type: none"> <li>● Press “+” till “6.2” appears on the display.</li> <li>● Press SET enter into the PB2 Port function setting.</li> </ul>
		 Execute OPEN–STOP–CLOSE the door action.Single–cycle function (default)
		 <ul style="list-style-type: none"> <li>● Execute CLOSE the door action ONLY at the open limit position.</li> <li>● Execute OPEN the door action ONLY at the close limit position.</li> <li>● Door opening action will be executed at any position other than the close/open limit position</li> </ul>
		 Execute ONLY OPEN the door action. No matter where the motor is and what state is triggered, the motor will perform ONLY OPEN action (Including radar, infrared sensors trigger)
		 Execute PARTIAL OPEN the door function. Refer to 
		 Execute Community function. Means: <ul style="list-style-type: none"> <li>● Execute ONLY OPEN the door action during the door closing process</li> <li>● But during the door opening process, it will not execute OPEN the door action, even though the motor is triggered</li> </ul>
	Remark :	 Execute OPEN–STOP–CLOSE the door action. Single–cycle function (default)
 Electronic lock function		<ul style="list-style-type: none"> <li>● Press and hold SET button for about 6 seconds to enter main menu until “0.—” appears on the display then release the button.</li> </ul>





 		<ul style="list-style-type: none"> <li>● Press “+” till “6.-” appears on the display .</li> <li>● Press SET then appears “6.0” on the display</li> <li>● Press “+” till “6.3” appears on the display .</li> <li>● Press SET enter into the Electronic lock function setting.</li> </ul>
		 Electronic lock function is off (default)
		 <p>Electronic lock function is enabled: 1 second after the door drive runs to the close limit position, the electronic lock is powered on, the bolt is pushed out, and after 1.5 seconds electronic lock stops supplying power . After the door drive receives the door opening command at the close limit position, the electronic lock will be powered on firstly to retract the bolt, then the door starts to run after 1.5 seconds, and the electronic lock stops power supply after the door runs for 1 second.</p>
	Remark :	The default electronic lock function is off .
 		<ul style="list-style-type: none"> <li>● Press and hold SET button for about 6 seconds to enter main menu until “0.-” appears on the display then release the button.</li> <li>● Press “+” till “6.-” appears on the display .</li> <li>● Press SET then appears “6.0” on the display</li> <li>● Press “+” till “6.4” appears on the display .</li> <li>● Press SET enter into the FLASH/Warning light output port setting.</li> </ul>
		Warning light flashes when the door is running, and warning light off when the door is stop. (default)





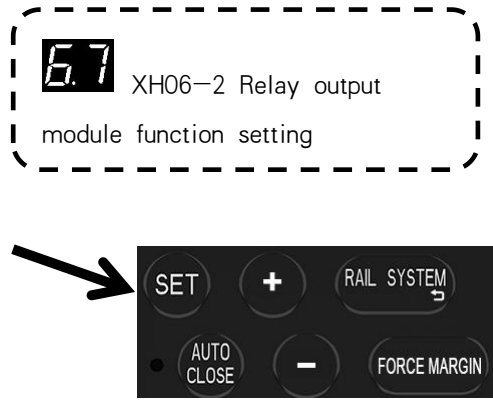











		<p>The warning light is always on when the door is running, and the warning light is off when the door is stop.</p>
		<p>The warning light flashes when the door is running, and the warning light flashes also when the door is stop.</p>
		<p>The warning light is always on when the door is running, and the warning light is always on also when the door is stop.</p>
		<p>The warning light flashes when the door is running, and the warning light is always on when the door is stop.</p>
		<p>The warning light is always on when the door is running, and the warning light flashes also when the door is stop.</p>
	<p>Remark :</p>	 means: Warning light flashes when the door is running, and warning light off when the door is stop. (default)
 		<ul style="list-style-type: none"> <li>● Press and hold SET button for about 6 seconds to enter main menu until "0.-" appears on the display then release the button.</li> <li>● Press "+" till "6.-" appears on the display.</li> <li>● Press SET then appears "6.0" on the display</li> <li>● Press "+" till "6.5" appears on the display.</li> <li>● Press SET enter into the Buzzer function setting</li> </ul>
		 The buzzer sounds when the door opening, but does not sound when the door closing.
		 The buzzer sounds when the door closing, but does not sound when the door opening
		 The buzzer sounds when the door drive is running, whether it's opening or closing

		The buzzer turns off.
	Remark :	The buzzer turns off. (default)

		<ul style="list-style-type: none"> <li>● Press and hold SET button for about 6 seconds to enter main menu until "0.-" appears on the display then release the button.</li> <li>● Press "+" till "6.-" appears on the display.</li> <li>● Press SET then appears "6.0" on the display</li> <li>● Press "+" till "6.6" appears on the display.</li> <li>● Press SET enter into XH06-1 Relay output module function setting. (Refer to page - 36 Relay module output terminal)</li> </ul>
		Reach the open limit position, relay closed
		Reach the close limit position, relay closed
		Reach the partial open limit position, relay closed
		Before the door drive running, the relay is closed first (1-7 seconds time adjustable) Press SET to confirm and directly enter the time setting. Adjust the stalls from  to  by buttons +/- . default: Represents 3 seconds.
		Relay always closed during the door drive running. After the door drive stops, relay will be disconnected after 1-10 minutes delay. (Adjustable time, similar to courtesy light OFF DELAY function). Press SET to confirm and directly enter the

		time setting. Adjust the stalls from  to  by buttons +/- . A=10.  means: 10 minutes;  default: Represents 3 minutes
		The relay is closed during door drive operation.
		When the door drive running, the relay flashes at a frequency of 1HZ (externally extended warning light function)
		Relay no action
	Remark :	 default. The customer can set the function according to the specific use situation and choose the appropriate function with the normally open (NO) and normally closed (NC) function of the relay.

		<ul style="list-style-type: none"> <li>● Press and hold SET button for about 6 seconds to enter main menu until "0.-" appears on the display then release the button.</li> <li>● Press "+" till "6.-" appears on the display.</li> <li>● Press SET then appears "6.0" on the display</li> <li>● Press "+" till "6.7" appears on the display.</li> <li>● Press SET enter into XH06-2 Relay output module function setting. (Refer to page - 36 Relay module output terminal)</li> </ul>
		Reach the open limit position , relay closed
		Reach the close limit position , relay closed

		Reach the partial open limit position, relay closed
		Before the door drive running, the relay is closed first (1–7 seconds time adjustable) Press SET to confirm and directly enter the time setting. Adjust the stalls from  to  by buttons +/-.
		default: Represents 3 seconds.
		Relay always closed during the door drive running. After the door drive stops, relay will be disconnected after 1–10 minutes delay. (Adjustable time, similar to courtesy light OFF DELAY function). Press SET to confirm and directly enter the time setting. Adjust the stalls from  to  by buttons +/- . A=10.
		means : 10 minutes ;
		default: Represents 3 minutes
		The relay is closed during door drive operation.
		When the door drive running, the relay flashes at a frequency of 1HZ (externally extended warning light function)
	Relay no action	
Remark :		default.
		The customer can set the function according to the specific application and choose the appropriate function with the Normal–Open (NO) and Normal–Close (NC) function of the relay.
 Safety device port function selection		<ul style="list-style-type: none"> <li>● Press and hold SET button for about 6 seconds to enter main menu until “0.—” appears on the display then release the button.</li> <li>● Press “+” till “6.—” appears on the display.</li> </ul>

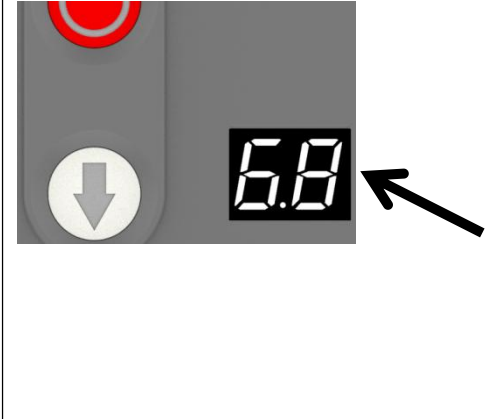
	<ul style="list-style-type: none"> <li>● Press SET then appears "6.0" on the display</li> <li>● Press "+" till "6.8" appears on the display.</li> <li>● Press SET enter into Safety device port function selection</li> </ul>						
	<table border="1"> <tr> <td data-bbox="734 448 861 526">1</td> <td data-bbox="861 448 1382 526">Electrical safety edge (Use 8.2K resistor without self-test)</td> </tr> <tr> <td data-bbox="734 526 861 604">2</td> <td data-bbox="861 526 1382 604">Optical safety edge (Three-wire infrared photo eyes.)</td> </tr> <tr> <td data-bbox="734 604 861 855">3</td> <td data-bbox="861 604 1382 855">Air pressure switch (DW) Note: Use 8.2K resistor for the DW self-test. Fault display code <b>Ed</b> appears when the DW self learn was failed, refer to the fault report page for a solution accordingly.</td> </tr> </table>	1	Electrical safety edge (Use 8.2K resistor without self-test)	2	Optical safety edge (Three-wire infrared photo eyes.)	3	Air pressure switch (DW) Note: Use 8.2K resistor for the DW self-test. Fault display code <b>Ed</b> appears when the DW self learn was failed, refer to the fault report page for a solution accordingly.
1	Electrical safety edge (Use 8.2K resistor without self-test)						
2	Optical safety edge (Three-wire infrared photo eyes.)						
3	Air pressure switch (DW) Note: Use 8.2K resistor for the DW self-test. Fault display code <b>Ed</b> appears when the DW self learn was failed, refer to the fault report page for a solution accordingly.						

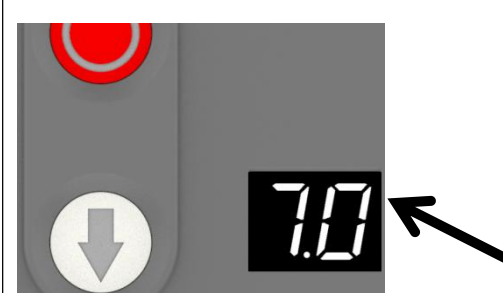
<p style="text-align: center;"><b>MENU7 <b>7.-</b> Courtesy Light Function Setting</b></p>															
<div style="border: 1px dashed black; padding: 5px; margin-bottom: 10px;"> <p><b>7.-</b> Courtesy light off delay time setting</p> </div>  	<table border="1"> <tr> <td data-bbox="734 1281 861 1344"><b>7.-</b></td> <td data-bbox="861 1281 1382 1344"> <ul style="list-style-type: none"> <li>● Press and hold SET button for about 6 seconds to enter main menu until "0.-" appears on the display then release the button.</li> </ul> </td> </tr> <tr> <td data-bbox="734 1344 861 1411"></td> <td data-bbox="861 1344 1382 1411"> <ul style="list-style-type: none"> <li>● Press "+" till "7.-" appears on the display.</li> </ul> </td> </tr> <tr> <td data-bbox="734 1411 861 1478"></td> <td data-bbox="861 1411 1382 1478"> <ul style="list-style-type: none"> <li>● Press SET into Courtesy light off delay time setting.</li> </ul> </td> </tr> <tr> <td data-bbox="734 1478 861 1545"></td> <td data-bbox="861 1478 1382 1545"> <ul style="list-style-type: none"> <li>● Press SET to enter the function menu, digital tube display <b>7.3</b>.</li> </ul> </td> </tr> <tr> <td data-bbox="734 1545 861 1612"></td> <td data-bbox="861 1545 1382 1612"> <ul style="list-style-type: none"> <li>● Adjust the stalls from <b>7.1</b> to <b>7.9</b> by buttons +/-.</li> </ul> </td> </tr> <tr> <td data-bbox="734 1612 861 1680"></td> <td data-bbox="861 1612 1382 1680"> <ul style="list-style-type: none"> <li>● <b>7.3</b> default, means 3 minutes delay.</li> </ul> </td> </tr> <tr> <td data-bbox="734 1680 861 1747"></td> <td data-bbox="861 1680 1382 1747"> <ul style="list-style-type: none"> <li>1 minute per stall. It is adjustable for 1-9</li> </ul> </td> </tr> </table>	<b>7.-</b>	<ul style="list-style-type: none"> <li>● Press and hold SET button for about 6 seconds to enter main menu until "0.-" appears on the display then release the button.</li> </ul>		<ul style="list-style-type: none"> <li>● Press "+" till "7.-" appears on the display.</li> </ul>		<ul style="list-style-type: none"> <li>● Press SET into Courtesy light off delay time setting.</li> </ul>		<ul style="list-style-type: none"> <li>● Press SET to enter the function menu, digital tube display <b>7.3</b>.</li> </ul>		<ul style="list-style-type: none"> <li>● Adjust the stalls from <b>7.1</b> to <b>7.9</b> by buttons +/-.</li> </ul>		<ul style="list-style-type: none"> <li>● <b>7.3</b> default, means 3 minutes delay.</li> </ul>		<ul style="list-style-type: none"> <li>1 minute per stall. It is adjustable for 1-9</li> </ul>
<b>7.-</b>	<ul style="list-style-type: none"> <li>● Press and hold SET button for about 6 seconds to enter main menu until "0.-" appears on the display then release the button.</li> </ul>														
	<ul style="list-style-type: none"> <li>● Press "+" till "7.-" appears on the display.</li> </ul>														
	<ul style="list-style-type: none"> <li>● Press SET into Courtesy light off delay time setting.</li> </ul>														
	<ul style="list-style-type: none"> <li>● Press SET to enter the function menu, digital tube display <b>7.3</b>.</li> </ul>														
	<ul style="list-style-type: none"> <li>● Adjust the stalls from <b>7.1</b> to <b>7.9</b> by buttons +/-.</li> </ul>														
	<ul style="list-style-type: none"> <li>● <b>7.3</b> default, means 3 minutes delay.</li> </ul>														
	<ul style="list-style-type: none"> <li>1 minute per stall. It is adjustable for 1-9</li> </ul>														

	<p>minutes. Select the delay time of the courtesy light, press the SET button to save setting, At the same time, enter the warning function setting of the courtesy light, digital tube display <b>0</b>, Adjust the stalls from <b>0</b> to <b>9</b> by buttons +/-.</p> <p><b>0</b> means the courtesy light operation warning function is off.</p> <p><b>0</b> to <b>9</b> means: The corresponding warning 1-9 second time selection, 1-9 second option means flashing before door drive starts running.</p>
	<p>Remark:</p> <p>a. After the door drive stops running, the courtesy light delay time can be adjusted from 1 ~ 9 minutes, the default is <b>7.3</b>, means 3 minutes off delay.</p> <p>b. After the courtesy light warning function is turned on, the courtesy light will flash for a corresponding time before the door drive runs each time, and then the door drive will start to perform actions.</p>

**MENU8 **8.-** Maintenance Alarm Function Setting**

**8.0** Maintenance alarm cycle-counting setting

SET

+

RAIL SYSTEM  
5

AUTO  
CLOSE

-

FORCE MARGIN



**8.0**

**0**





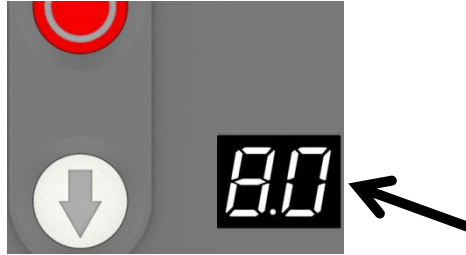
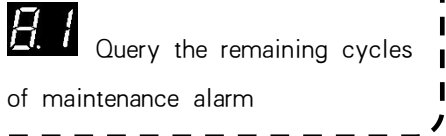
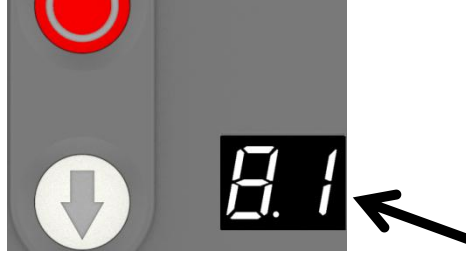

- Press and hold SET button for about 6 seconds to enter main menu until "0.-" appears on the display then release the button.
- Press "+" till "8.-" appears on the display. Press SET then "8.0" appears on the display.
- Press SET to enter the Maintenance alarm cycle-counting setting.

**0** Indicates that the maintenance

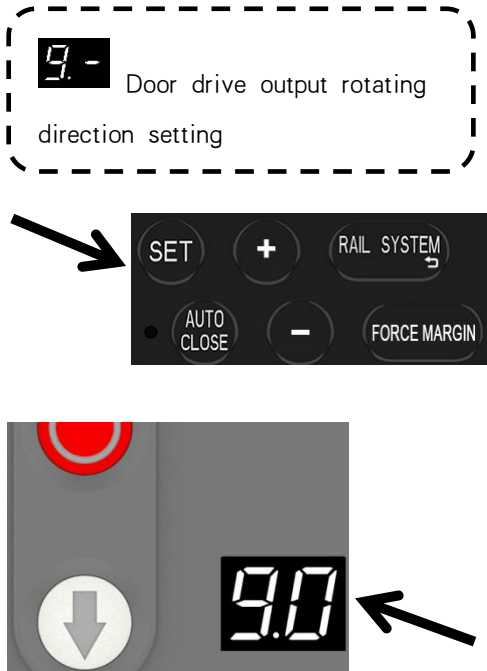









		<p>alarm function is closed (factory default)</p> <p>Press SET to enter the function menu, digital displays <b>0</b> (factory default).</p> <p>Adjust the stalls from <b>.1</b> to <b>8</b> then <b>F</b> by buttons +/-.</p> <p>500 cycles per stall.</p> <p>Cycles—calculation method is <math>500 \times N</math>, <math>N=01-15</math>. A=10; F=15</p> <p>e.g.</p> <p><b>.1</b> means: <math>1 \times 500 = 500</math> cycles;</p> <p><b>2</b> means: <math>2 \times 500 = 1000</math> cycles;</p> <p><b>A</b> means: <math>10 \times 500 = 5000</math> cycles;</p> <p><b>F</b> means: <math>15 \times 500 = 7500</math> cycles</p>
<div style="border: 1px dashed black; padding: 5px; margin-bottom: 10px;">  </div> 		<ul style="list-style-type: none"> <li>● Press and hold SET button for about 6 seconds to enter main menu until "0.-" appears on the display then release the button.</li> <li>● Press "+" till "8.-" appears on the display. Press SET then "8.0" appears on the display.</li> <li>● Press "+" till "8.1" appears on the display, Press SET to enter the Query the remaining cycles of maintenance alarm</li> </ul>
		<p>Press SET to enter the function query, the digital will circulated display <b>-1000-</b>, then after the cumulative loop display 3 times, the query display will exit.</p>
	<p>Remark :</p>	<p>a. Running cycles counter will not be cleared even after the door drive is</p>

		<p>restored to factory settings.</p> <p>b. Maintenance alarm description (Running cycles will minus 1 cycle, after the door drive reaching the close limit position each time)</p> <p>c. When the maintenance alarm count shows 0, when the door drive runs to the open and close limit positions each time, the courtesy light will flash quickly, the buzzer will sound continuously to remind the customer that the door and the drive unit need maintenance, and the digital tube will display fault <b>EA</b>.</p> <p>d. After the maintenance of the door or drive unit is completed, the maintenance personnel need to re-enter the menu to set the maintenance alarm cycles, and the cycles of maintenance alarms will restart to count.</p>
--	--	--

<b>MENU9  Gear Motor Running Direction Rotating Setting</b>		
 <p> Door drive output rotating direction setting</p>		<ul style="list-style-type: none"> <li>● Press and hold SET button for about 6 seconds to enter main menu until “0.-” appears on the display then release the button.</li> <li>● Press “+” till “9.-” appears on the display.</li> <li>● Press SET to enter the Door drive output rotating direction setting</li> </ul>
		 Door drive rotating direction is forward. (Default)
		 Door drive rotating direction is reverse
<p>Remark :</p>		<p>After adjusting the rotating direction of the door drive, it is necessary to relearn the travel limit.</p>

## FAULT DISPLAY

Fault Display Code	Fault Description	Fault Correction
	Encoder failure, the encoder cannot write and read data	<ol style="list-style-type: none"> <li>1. Replace the encoder</li> <li>2. Replace the encoder cable</li> </ol>
	No motor motion signal is detected,	<ol style="list-style-type: none"> <li>1. Check whether the wiring between the limiter and the control board is loose.</li> </ol>
	The positive and negative poles of the motor wire are reversed	<ol style="list-style-type: none"> <li>1. Exchange the positive and negative poles of the motor</li> </ol>
	Motor current is too high	<ol style="list-style-type: none"> <li>1. Choose matching control system and motor</li> <li>2. Check the door body</li> <li>3. Replace the high-power door drive</li> </ol>
	Door drive overload alarm, current overrun	<ol style="list-style-type: none"> <li>1. The door is stuck or the door is too heavy</li> <li>2. The door size is too large</li> <li>3. Check the door body</li> <li>4. Replace the high-power door drive</li> </ol>
	Optical safety edge sensor kit fault	<ol style="list-style-type: none"> <li>1. 8.2K resistor is open circuit, missing installation</li> <li>2. The conductive tape edge is aging or broken</li> </ol>
	Infrared/infrared light curtain function port is triggered	<ol style="list-style-type: none"> <li>1. Check whether the infrared function is turned on</li> <li>2. Turn on the infrared function to detect whether the infrared device is blocked</li> <li>3. Check whether the NO/NC wiring of the infrared device output port is wrong. The NO port is connected by default, and the port is closed after the shot</li> </ol>
	SD (Pass door/wicket door) switch is triggered	<ol style="list-style-type: none"> <li>1. Check whether the SD function port of the secure port is not connected</li> </ol>
	The maintenance alarm cycle reaches	<ol style="list-style-type: none"> <li>1. Notify maintenance personnel to maintain the door and drive</li> </ol>

<b>E9.</b>	Safety port three-wire infrared fault	<ol style="list-style-type: none"> <li>1. The three-wire infrared electric photo eye is blocked</li> <li>2. Three-wire infrared electric photo eye failure</li> <li>3. Is the three-wire infrared electric photo eye a product of our company?</li> </ol>
<b>EA.</b>	Emergency chain manual release port fault	<ol style="list-style-type: none"> <li>1. Check if the manual release port have short circuits</li> <li>2. Manual release is not reset</li> <li>3. Manual release switch failed</li> </ol>
<b>EB.</b>	Communication failure between door drive and control box.	<ol style="list-style-type: none"> <li>1. Re-plug the RJ45 interface</li> <li>2. The door drive needs to be powered off and restarted</li> <li>3. Replace the 8P network cable.</li> </ol>
<b>EC.</b>	Short learning travel limit	<ol style="list-style-type: none"> <li>1. Re-learn the travel limit</li> <li>2. Encoder position data failure</li> </ol>
<b>ED.</b>	Air pressure switch (DW) self-test failure	<ol style="list-style-type: none"> <li>1. Check the NC air switch (DW) device performance.</li> <li>2. Check the air leak possibility from installation.</li> </ol>
<b>EE.</b>	During the self-learning of the travel limit, if the rotor is blocked or the encoder is faulty, the buzzer will sound once and display "EE."	<ol style="list-style-type: none"> <li>1. Re-learn the limit position.</li> <li>2. Check the encoder connection</li> <li>3. Replace the encoder</li> </ol>
<b>EF.</b>	The emergency stop switch function is triggered.	<ol style="list-style-type: none"> <li>1. Check whether the emergency stop switch is pressed</li> <li>2. Whether the emergency stop switch uses a normally closed (NC) switch</li> <li>3. Whether the external port STOP short-circuit connection is loose</li> </ol>

## TX/RX FUNCTION MODULE DESCRIPTION (optional)

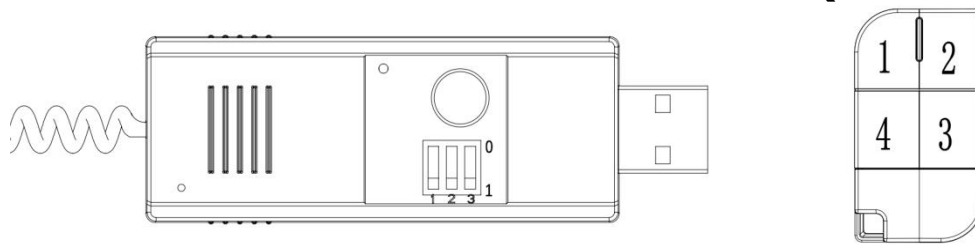

1. The external decoding module uses the standard HCS301 format open code, the frequency 433MHZ/868MHZ is optional,
2. Transmitter 4 button design; Transmitter key value 1, 8, 2, 4
3. The transmitter module and control box use USB standard interface to connect
4. Short press the LEARN button on the module, the LED will light up, press the remote control to learn the code. Long press the learn button on the module for 6 seconds, LED will flash 5secondsquickly to clear the code
5. The default maximum number of transmitter storage is 50codes, and if 50 codes is already learned, the 51<sup>st</sup>codewill automatically cover the 1<sup>st</sup>code.
6. **Transmitter module function:**
  - a. Standard function: Single key cycle
  - b. Ignore the key value function, all keys are valid: OPEN—STOP—CLOSE command order each cycle. As long as learning a key, the others are valid
  - c. Multiple function key 1:
    - 1<sup>st</sup> button execute OPEN—STOP—CLOSE command order each cycle ;
    - 2<sup>nd</sup> button execute PARTIAL OPEN command order;
    - 3<sup>rd</sup> button execute courtesy light ON/OFF command order;
    - 4<sup>th</sup> button execute remote LOCK command order;
  - d. Multiple function key 2:
    - 1<sup>st</sup> button execute OPEN the door command order;
    - 2<sup>nd</sup> button execute STOP command order;
    - 3<sup>rd</sup> button execute CLOSE the door command order;
    - 4<sup>th</sup> button execute remote LOCK command order;
  - e. Multiple function key 3:
    - 1<sup>st</sup> button execute OPEN the door command order;
    - 2<sup>nd</sup> button execute STOP command order;
    - 3<sup>rd</sup> button execute CLOSE the door command order;
    - 4<sup>th</sup> button execute “CF” command order; (“CF” command order means press the 4<sup>th</sup> button, the door will OPEN directly without STOP action, execute the REVERSE action during door closing)
7. Adjust the transmitter function through the three—circuit DIP switch

### Important Note:

When using multiple function keys, you must use our company's standard transmitter. The transmitter provided by the customer has inconsistent key values, which may cause function failure.

S1	S2	S3	Function Description
1	1	1	Standard function (Factory default)
0	1	1	Ignore the key value function
1	0	1	Multiple function key 1
1	1	0	Multiple function key 2
0	0	1	Multiple function key 3

## FUNCTION WIRING DIAGRAM

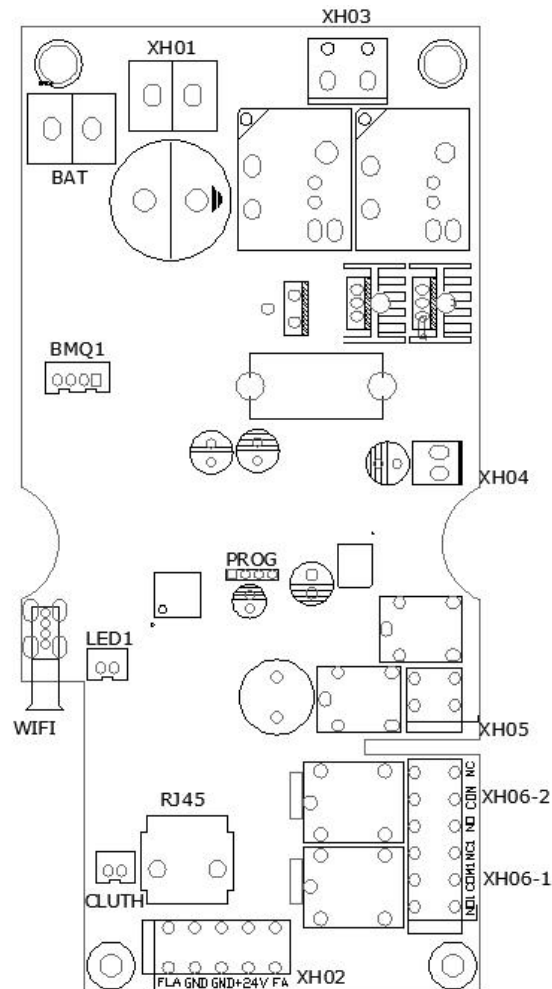

XH01	AC24V Power input terminal
XH02	Warning light output port, DC24V output terminal/FA Fire alarm port
XH03	Gear motor power supply terminal
XH04	DC24V Input terminal
XH05	Electronic lock terminal
XH06-1/XH06-2	Relay module output terminal
BAT	Lead-acid battery input terminal
RJ45	Control box terminal
WIFI	WIFI control terminal
LED1	Courtesy light terminal
CLUTH	Rear clutch protection terminal

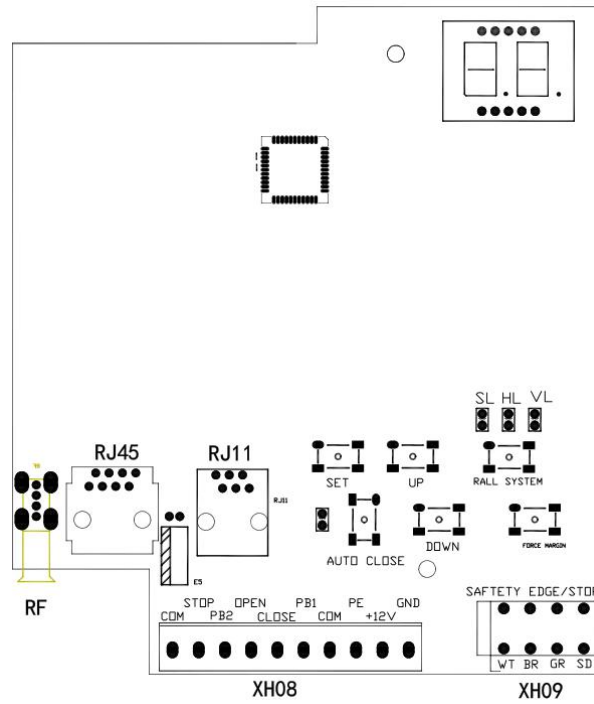

XH08	External function terminal
XH09	Safety terminal
RJ45	Control box and power head connection
RJ11	External wired wall control connection
RF	Transmitter & Receiver module terminal

## XH02 Door drive output terminal

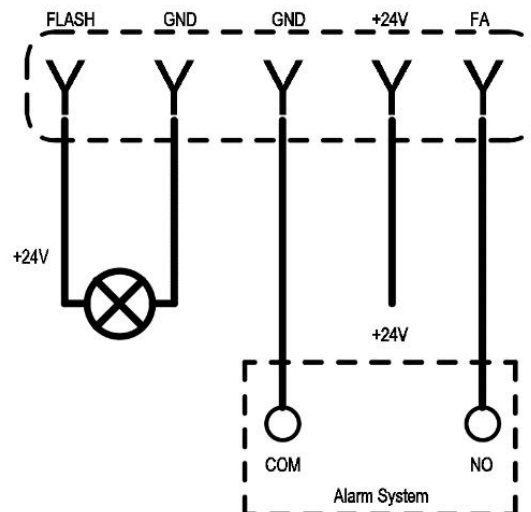

FLASH/GND	DC24V warning light output terminal, drive MAX current 0.2A, function menu <b>64</b> , define function status
+24V/GND	DC 24V/ MAX 0.2A
GND/FA	The terminal of the fire alarm device (Default NO) . Remark: The door will be opened to the opening limit position automatically once the FA terminal is triggered (No matter what status the door is) and the door cannot execute any other action commands until the FA terminal returns to the NO (Normal open) state.

## XH05 Electronic lock output terminal

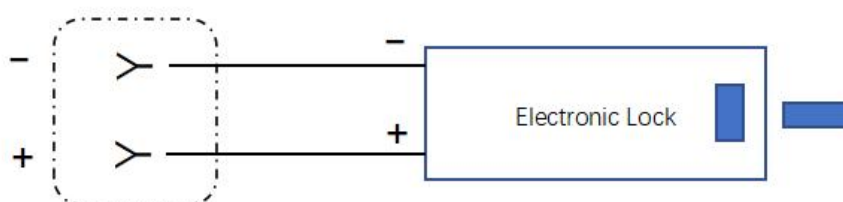

+/-	±24V Electronic lock output terminal, output current max. 2A, time 3S, function menu <b>63</b> enabled
-----	--



## XH06 Relay module output terminal

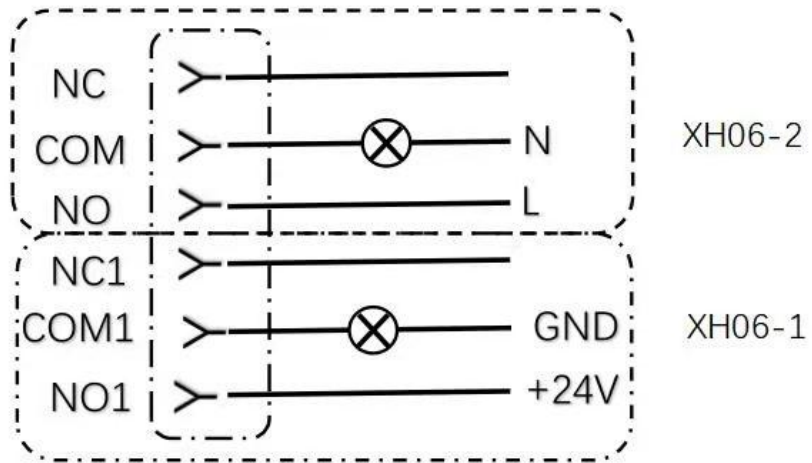

NC/COM/NO	XH06-2 Relay output module, max 100w. See the function menu <b>6.7</b> for details
NC1/COM1/NO1	XH06-1 Relay output module, max 100w. See the function menu <b>6.6</b> for details

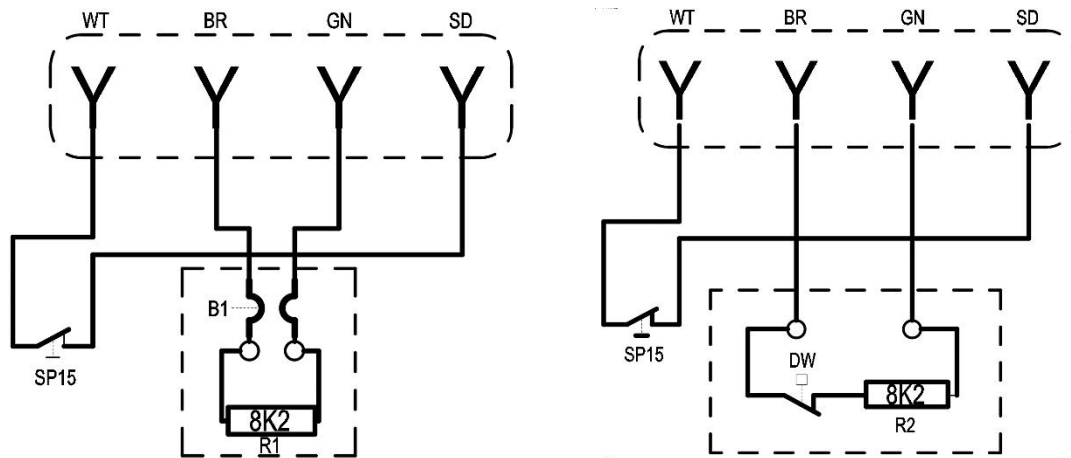

## XH09 Safety terminal

(Wicket door protection/ Electrical safety edge/ Air pressure switch)



WT	GND
BR	+12V
GN	Signal
SP15/SD	Wicket door/ Pass door protection device terminal
DW (Air pressure switch)	Activate function menu <b>58</b> / <b>3</b> to enable (DW) air pressure switch Remark: Only NC (Normal close) contact air pressure switch
Note1: SP15 is disconnected, the door drive stops, and all control functions are invalid. Note2: The Electrical safety edge is short-circuited during the closing process, and the door drive will automatic reverse.	

## DW (Air pressure switch) self-test instruction

● Correctly installed the Air Pressure Switch and then enter the menu  /  to enable the DW function.

● (DW self-test successfully)

Short press the "DOWN" button to close the door. The air pressure switch self-test is performed automatically when the door is closed to the closing limit position. If the air pressure switch (DW) is triggered during the door closing process, the door will be automatic reverse, which means the DW self-test is successfully.

● (DW self-test failed)

Short press the "DOWN" button to close the door. The air pressure switch self-test is performed automatically when the door is closed to the closing limit position. If the air pressure switch

(DW) is NOT triggered during the door closing process, and the display shows faulty , which means the DW self-test is failed. Then the dead man mode will be enabled automatically

during the next door closing operation. Check the air switch device (Refer to faulty  description page) to fix the issues and repeat the above self-test operation until it's succeed.

**Remark:** Fine adjust the pre-close limit position for DW, refer to the menu .

## XH09 Safety terminal

(Optical safety edge/ three-wire infrared photo eyes/wicket door protection)

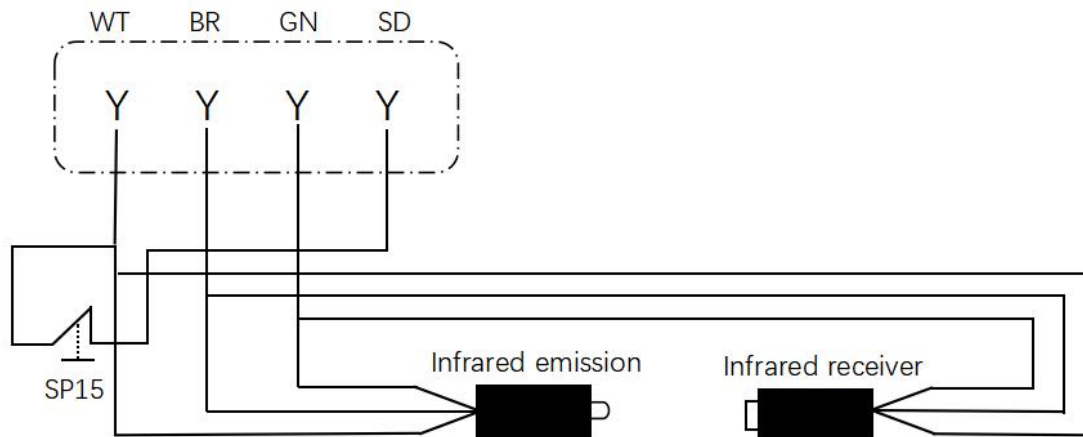

WT	GND
BR	+12V
GN	Signal
Optical safety edge	Enter the function menu <b>6.0</b> / <b>2</b> to enable the optical safety edge system/Three-wire infrared photo eyes
SP15/SD	Wicket door/ Pass door protection device terminal
Note 1: SP15 is disconnected, the motor stops, and all control functions are invalid.	
Note 2: The door will automatically reverse once the Optical safety edge system is triggered during the door's closing process.	

# XH08 Safety terminal

(Infrared sensors/ light curtain)

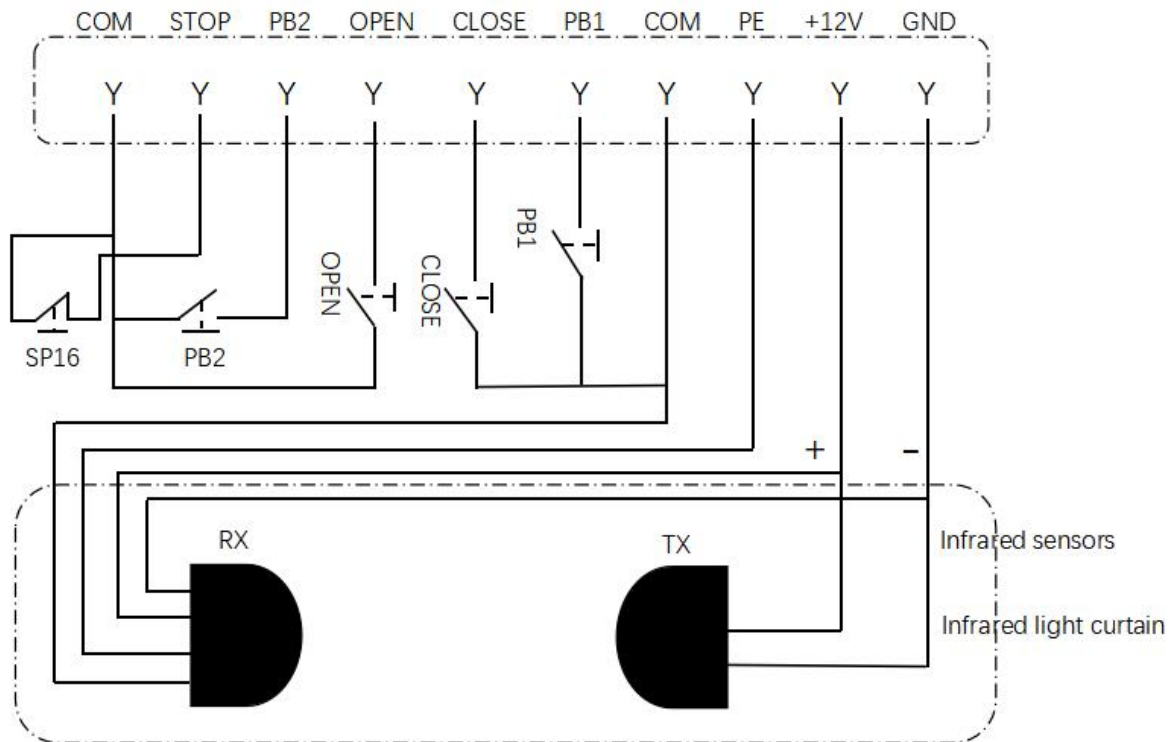

STOP	Emergency stop normally closed (NC) port, after disconnection, the door drive executes long press operation mode
PB2	Door drive operation control terminal, see details for specific functions <b>6.2</b> / <b>6.2</b> Function menu normally open (NO) port
OPEN	External door opening terminal normally open (NO) port
CLOSE	External door closing terminal normally open (NO) port
PB1	Door drive operation control terminal, see details for specific functions <b>6.1</b> / <b>6.1</b> Function menu normally open (NO) port
PE	Infrared sensors/ Built-in infrared sensors/ Light curtain, Details in <b>5.1</b> function menu.
12V/GND	DC12V Output power, max 0.2A

Date Version: 19/06/2024